

IVECO T-WAY
DRIVE THE NEW WAY



IVECO

Your partner for sustainable transport



IVECO T-WAY DRIVE THE NEW WAY

The IVECO T-WAY is the vehicle you want for the toughest missions in the most extreme conditions. With its perfect combination of robustness, reliability and comfort, it is designed to meet your requirements and exceed all your expectations on productivity, payload capacity, and safety.

With the legendary robustness of its chassis and components, it is built to perform extreme off-road missions.

The IVECO T-WAY raises the drivers on-board experience to a new level with the new cab designed around their needs. It integrates the most advanced features of the new IVECO WAY range to provide an extremely comfortable and safe environment.

The most reliable and productive heavy-duty truck in a construction environment, the IVECO T-WAY is truly unstoppable and equal to the toughest challenges.

ROBUSTNESS AND RELIABILITY	04	TIPPER	16
NEW FUNCTIONAL DESIGN	06	A WIDE VARIETY OF MISSIONS	18
PREMIUM DRIVING COMFORT	08	CHOOSE YOUR CONFIGURATION	21
MOBILITY AND SAFETY ON ALL TERRAINS	10	ELEMENTS	23
HIGH VERSATILITY TO MATCH YOUR MISSION	12	IVECO ACCESSORIES	24
MIXER	14	IVECO SERVICES	25
		CHOOSE YOUR IVECO T-WAY MODEL	26

ROBUSTNESS AND RELIABILITY



The IVECO T-WAY has been engineered and built to guarantee reliability and durability in the toughest challenges and environments. The legendary robustness of the high resistance steel chassis with a 10 mm thick frame, combined with the suspension system's high resistance, contribute to the excellent performance in the harshest conditions.



The new rear axles and the new-design air suspension for tandem axles have been tested in the harshest conditions. The redesign of a number of components contributes to a kerb weight optimization up to 500 kg, increasing the IVECO T-WAY's payload capacity.

NEW FUNCTIONAL DESIGN

The cab has been entirely redesigned focusing on functionality to facilitate the driver's daily work with features that improve visibility, protect from dirt, and much more. The new design also simplifies maintenance and repair operations, making it easier to change components. The chassis layout has been entirely reviewed to facilitate the customization of bodybuilders.

IMPROVED BRAKE PERFORMANCE
WITH NEW FRONT AXLES AND DISK BRAKES

COMPLETE PTO OFFERING

HI-TRONIX AUTOMATED GEARBOX AVAILABLE

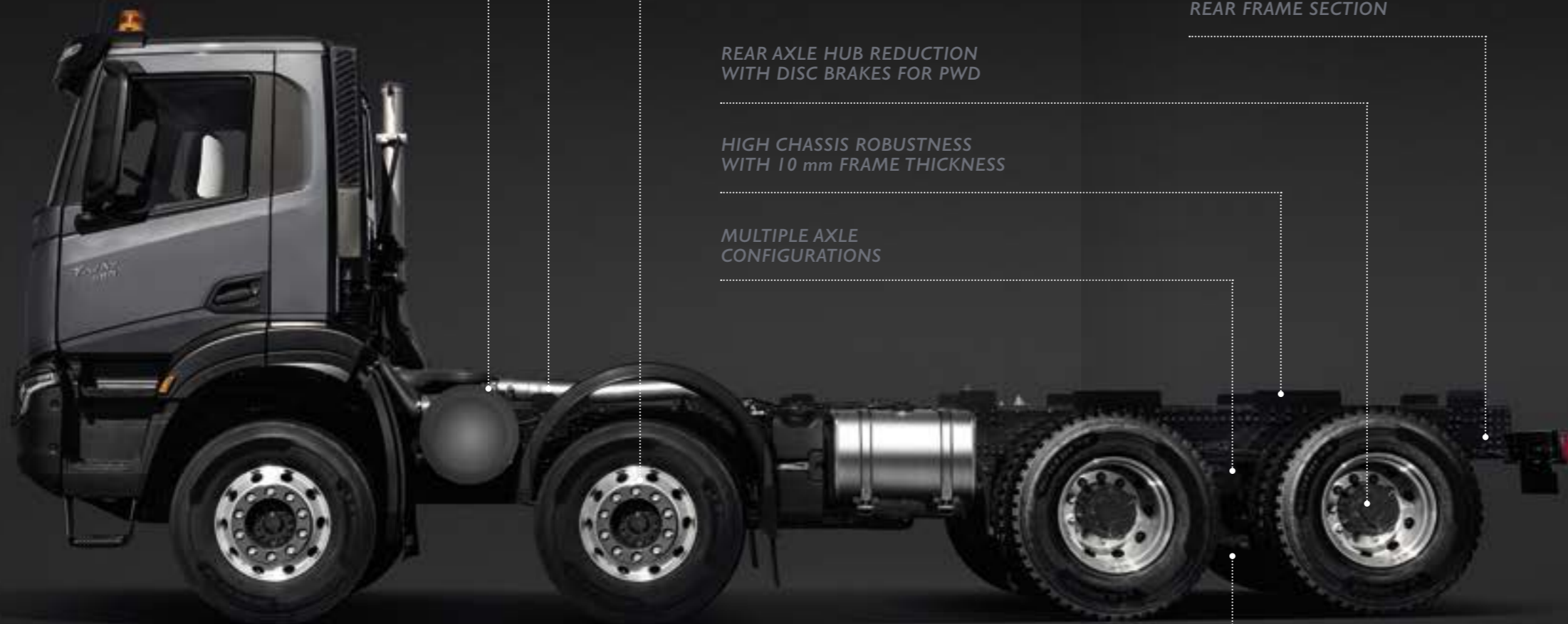

REAR AXLE HUB REDUCTION
WITH DISC BRAKES FOR PWD

HIGH CHASSIS ROBUSTNESS
WITH 10 mm FRAME THICKNESS

MULTIPLE AXLE
CONFIGURATIONS

KERB WEIGHT OPTIMIZATION UP TO 500 kg

CHOICE OF MECHANICAL AND PNEUMATIC SUSPENSIONS

IMPROVED SAFETY
FUNCTIONALITIES – LDWS, ESP & EBS

FRONT GRILL DESIGN

OPTIMISED MIRROR DESIGN

CONSTANT
REAR FRAME SECTION



MULTI-PIECE BUMPER

FULL LED HEADLIGHTS AND PROTECTION GRID

FOLDABLE STEP

PREMIUM DRIVING COMFORT

The entire driver area has been created to provide the ultimate driving environment with outstanding ergonomics and controls layout, more space and excellent visibility. Every single detail has been carefully studied to meet the driver's expectations on the road.

STEERING WHEEL

All the vehicle's key functions at your fingertips

INTEGRATED HVAC SYSTEM

Heating, ventilation and air conditioning

KEY LOCK AREA

Turn the engine on and off by simply pushing the Start/Stop button

INFOTAINMENT

Bring your digital life on board with smartphone mirroring and innovative features

TWILIGHT & RAIN SENSOR

Automatically turns on the headlights and windscreen wipers



Dashboard AD-AT cab



Customize your seats with leather or fabric upholstery and enjoy the luxurious comfort of the cushions.



Choose the soft touch or leather steering wheel, both available in the classic shape or with the distinctive flat base.



Internal AD cab

MOBILITY AND SAFETY ON ALL TERRAINS

The IVECO T-WAY can rely on a vast range of features and functionalities to perform every type of mission flawlessly, delivering consistently high productivity on all terrains and conditions. It will complete your mission efficiently, ensuring the highest safety levels on- and off-road.

HI-TRONIX GEARBOX WITH OFF-ROAD FUNCTIONALITIES

With the 16-speed HI-TRONIX automated gearbox you can benefit from a host of functionalities such as Rocking Mode, Off-road Mode, Creeping Mode and 4 reverse gears to tackle with ease the toughest off-road conditions.

FULLY MODULAR SUSPENSION CONCEPT

The IVECO T-WAY offers ultimate flexibility with a choice of air and mechanical suspensions – both parabolic and semi-elliptic.

AWD (ALL WHEEL DRIVE) & PWD (PARTIAL WHEEL DRIVE)

The IVECO T-WAY offers a complete line-up of AWD and PWD to meet the requirements of every mission – even the most demanding.

BRAKES PERFORMANCE AND SAFETY IMPROVEMENTS

The new architecture of the EBS system, combined with disc brakes on all wheels, has dramatically improved the vehicle's performance, and consequently the safety of the driver, vehicle and other road users.



EBS
Electronic Braking System

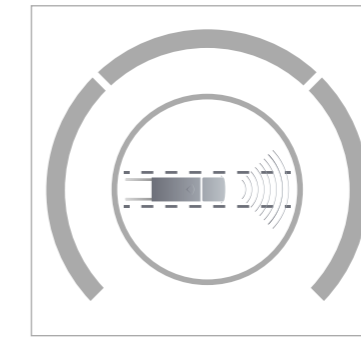

BAS
Brake Assistant System



ESP
Electronic Stability Program



LDWS
Lane Departure Warning System

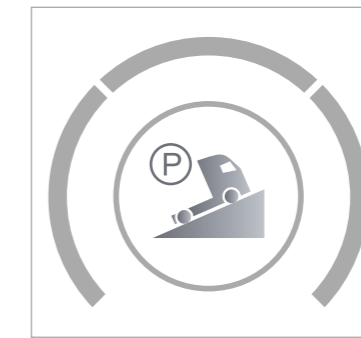

HILL HOLDER

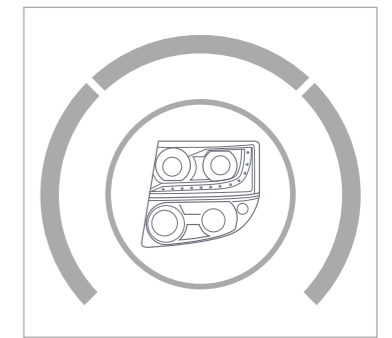

LED DRL
Daytime Running Lights

EBS+BAS

Electronic Braking System + Brake Assistant System

Combines the ABS, ASR (Acceleration Slip Regulation) functions, ensuring shorter stopping distances and uniform brake pad wear.

Improves braking in emergency conditions, combining the action of the engine brake and the INTARDER (retarder).

ESP

Electronic Stability Program

Regulates the power of the engine and brakes on the individual wheels in the event of understeer, oversteer or sudden changes in trajectory in order to stabilise the vehicle.

LDWS

Lane Departure Warning System

Alerts the driver if the vehicle crosses the lane markers without prior activation of the turn indicators.

HILL HOLDER

In hill starts, prevents the vehicle from rolling back for a few seconds after the brake pedal is released.

LED DRL

Daytime Running Lights

Keeps the daytime running lights on at all times to ensure the maximum visibility of the vehicle. Bi-xenon and conventional lights available.



HIGH VERSATILITY TO MATCH YOUR MISSION

The IVECO T-WAY is a highly versatile vehicle: with its legendary robustness, high payload capacity, kerb weight optimization, and wide offering of features and components, it can be tailored to precisely match the requirements of your mission.



MISSION

MIXER	14-15
TIPPER	16-17
A WIDE VARIETY OF MISSIONS	18-19

MIXER

The IVECO T-WAY is built to carry massive payloads on all terrains – it can mount concrete mixers of high capacity up to 12 m³ for a 40-tonne GVW.

IMPROVED DIRECT AND INDIRECT VISIBILITY

The aerodynamic design of the mirrors and their optimized positioning further improves visibility. The rear window of the AD/AT cabs provides excellent visibility on the rear of the vehicle.

NEW ESP AND LDWS

Functionalities for Safety improvement.

POWERFULLY EFFICIENT ENGINES

The 13-litre engine deliver all the power you need with outstanding fuel efficiency.

IDEAL POWER TAKE-OFF

The IVECO T-WAY offers a choice of permanently engaged PTOs that with the new sandwich PTO deliver up to a maximum of 2300 Nm, which is perfect for a mixer body combined with a concrete pump.

MECHANICAL OR AUTOMATED GEARBOX

The automated gearbox provides greater driving comfort in these vehicles that typically travel short distances and are frequently caught in traffic.

EXCELLENT MANOEUVRABILITY

The offering of axle configurations and wheelbases delivers excellent manoeuvrability and turning circle.

ROBUST CHASSIS

The legendary strength of the chassis, with its 10 mm frame with constant section, means that it can carry high-capacity concrete mixers.

FRONT AND REAR BRAKES

Both Disc and Drum brakes configurations available to cover all Mission.

KERB WEIGHT OPTIMIZATION up to 500 kg – depending on the number of axles, thanks to:

- New one-piece suspension support of suspension system
- EBS and Full Air Disc Brakes
- Alloy wheels option
- Aluminium air tanks option

NEW HI-MUX ELECTRONIC ARCHITECTURE

Wider Body Buildings interfaces and connectivity.



TIPPER

The IVECO T-WAY will drive wherever you need it to go, carrying big payloads in all conditions – from unmetalled roads to extreme off-road terrains, in all weathers and in the harshest environments.

IMPROVED DIRECT AND INDIRECT VISIBILITY

The aerodynamic design of the mirrors and their optimized positioning further improves visibility. The rear window of the AD/AT cabs provides excellent visibility on the rear of the vehicle.

NEW ESP and LDWS

Functionalities for Safety improvement.

ENGINES

The line-up offers different engine ratings to deliver the right power and torque for your mission.

FRONT AXLE

Leaf springs with load capacity up to 9 tonnes.

COMFORTABLE AND SAFE ACCESS

Well placed handles and footsteps provide safe access to the cab and tipping bridge. The dropdown lowest step is hung with rubber straps to better absorb shocks.

FRONT AND REAR DISC BRAKES ON PWD CONFIGURATION

Disc brakes ensure better deceleration, and involve lower maintenance costs and less wear and tear.

POWER TAKE-OFF

The body lifting hydraulic circuit is driven by a gearbox or engine PTO that delivers the power needed to operate all types of tipper.

CHOICE OF GEARBOXES

Manual or automated: choose your transmission according to the type of road use – maximise comfort and safety while reducing operating costs.

PAYLOAD

With its robust chassis and weight optimization, the IVECO T-WAY designed to be equipped with high-capacity tippers and carry big payloads.

WIDE OFFER OF CHASSIS

Choose from a wide offering of wheelbases, ranging from 3300 mm to 5820 mm, and rear overhang lengths.

REAR SUSPENSIONS

The IVECO T-WAY offers a choice of front and rear suspensions (parabolic, reinforced, multi-leaf) in combination with all configurations to optimize stability and robustness in all conditions.

MULTIPLE AXLE CONFIGURATIONS

Choose from a wide variety of configurations to match your exact needs.



A WIDE VARIETY OF MISSIONS

CRANE & PLATFORM

The IVECO T-WAY can be fitted with every type of crane, from flatbed to platform cranes. The robustness and modular concept of the vehicle enables us to fit cranes at the back of the cab, in a central position or at the rear of vehicle with no compromise on stability.

TIMBER

The IVECO T-WAY delivers the high power you need and offers the ideal features to load, transport and unload timber with ease. It will transport your logs comfortably in forests and woods, on the roads, and all the way to your destination: our powerful engines, the robust chassis and big payload capacity are all features designed for this multi-faceted mission.

GULLY CLEANER

The IVECO T-WAY is optimized for the easy installation of a gully cleaner body and to provide all the features you need. High performance is essential in this mission, and the new clutch independent sandwich PTO designed to unleash up to 2300 Nm delivers the huge torque required.



TIPPER SEMITRAILER

IVECO T-WAY tractors in 6x4 configuration combine the best fuel efficiency with the ultimate safety technologies of the new cab. These features give you the confidence to tackle with ease the most difficult conditions of jobsites while ensuring high productivity, safety and delivering excellent Total Cost of Ownership.

CONCRETE (PUMPS, MIXER, MIXER PUMPS)

With the IVECO T-WAY you can meet every construction site requirement for concrete – from a simple concrete mixer to pumps and mixer pumps. The introduction of a complete range of PTOs in various positions on the vehicle enables us to meet the needs of every application with torque above 2000 Nm.

PUBLIC UTILITIES

The vast choice of configurations and extreme versatility mean that the IVECO T-WAY range is able to meet the requirements of a wide variety of applications – from road resurfacing to snow clearing, from waste collection to road services.

CHOOSE YOUR CONFIGURATION

The modular, mission-oriented approach of the IVECO T-WAY with a wide choice of features and components, together with the structural strength and low kerb weight, provides ultimate flexibility in customizing the vehicle to the specific requirements of a wide variety of applications.

CABINS

The IVECO T-WAY cab line-up offers a choice of cabs to match your mission: the **AT** sleeper cab with low or medium roof, and the **AD** short cab with low roof.

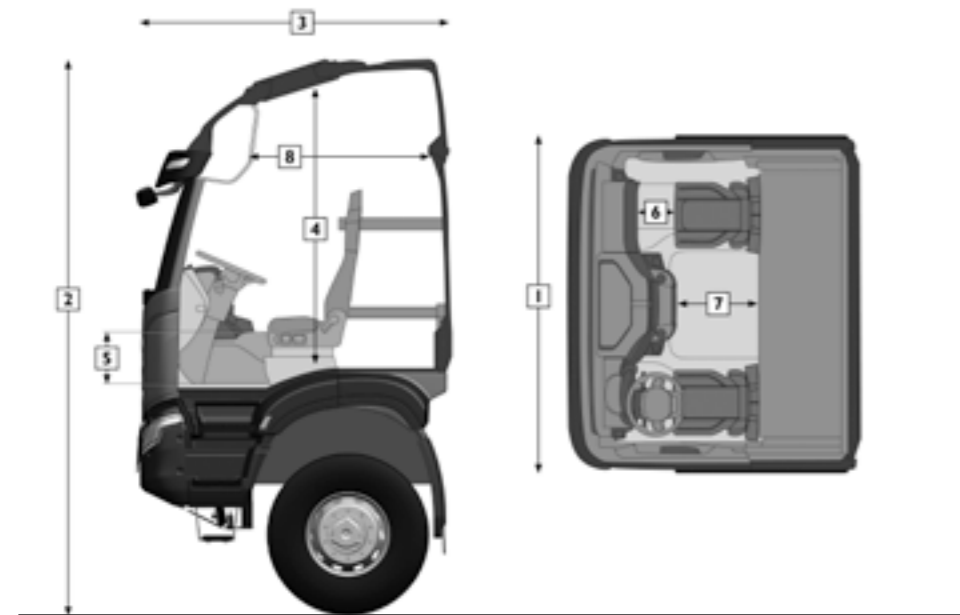

LEGEND

- 1 Width
- 2 Overall Height
- 3 Length
- 4 Floor to Roof Cab Centre
- 5 Tunnel Height
- 6 Passenger Usable Space
- 7 Lower Usable Space
- 8 Upper Usable Space

	1	2	3	4	5	6	7	8			
	Roof	Width (mm)	Overall Height (mm)	Length (mm)	Floor to Roof Cab Centre (mm)	Tunnel Height (mm)	Passenger Usable Space (mm)	Lower Usable Space (mm)	Upper Usable Space (mm)	Bunk ⁽²⁾	Boarding Steps
AT											
Medium		2300	3550 ⁽¹⁾	2150	1850	340	370	470	480	1 (2)	3
Low		2300	2900 ⁽¹⁾	2150	1250	340	370	470	-	1	
AD											
Low		2300	2550 ⁽¹⁾	1700	1250	340	370	-	-	0	3

Dimensions can vary according to the model

NOTE

⁽¹⁾ Approximate measures; may change based on suspensions, assembly variables and approximations.

⁽²⁾ Upper bed as option.

AT Cab

Lower bunk length 1950 mm, width 540 mm, upper bunk length 1850 mm, width 680 mm.

ENGINES

IVECO T-WAY introduces the new Cursor 13 litres Common Rail engine with different engine ratings from 430 to 480 hp to suit all the applications and deliver class leading power.

ENGINES/GEARBOX EURO III - EURO V

ENGINE	DISPLACEMENT (litres)	TURBO	POWER (hp)	TORQUE (Nm)	MANUAL 16 SPEED	AUTOMATED 16 SPEED
					ZF Ecosplit	ZF Hi-Tronix
					HR axle	HR axle
CURSOR 13 Common Rail	12.9	WG	430	2100	16 S 2220 TO (2200 Nm)	16 TX 2240 TO (2200 Nm)
			470	2200		
			*480	2200	16 S 2520 TO (2500 Nm)	16 TX 2240 TO (2200 Nm)

*Euro V version only.



Cursor 13

POWER TAKE OFF

	DEPENDENT / INDEPENDENT FROM TRANSMISSION	CONNECTION	RATIO	TORQUE (Nm)	ROTATION
ENGINE PTO					
Switchable	Independent	Pump / Flange	1.12 / 1.14	800	Opposite engine
Not switchable			1.14 / 1.195		
SANDWICH PTO					
Switchable	Independent	Flange	1.02 / 1.27 / 1.56	1602 – 2300	Same as engine
MULTIPOWER PTO					
Switchable	Independent	Flange	1.29	900	Same as engine
Not switchable					
GEARBOX PTO					
NH/1b – NH/1c	Dependent	Pump / Flange	1.00	1000	Opposite engine
NH/4b – NH/4c			0.90 / 1.28	430	Same as engine
NTX/10b – NTX/10c			0.91 / 1.09 / 1.28 / 1.59	490 – 720	
NTX/10c+bR			(0.91-1.28) / 1.09-1.59	490 – 720	



ELEMENTS

PICK THE SERVICES THAT PERFECTLY MATCH YOUR BUSINESS

The IVECO T-WAY offers an extensive range of services that can be tailored to your precise requirements to keep your vehicle running in top form and your business operating with a healthy bottom line.

The IVECO T-WAY introduces an entirely new level of customisation through connectivity. The real-time vehicle data it provides enables us to offer you **bespoke maintenance plans** based on the real use of your IVECO T-WAY – a perfect match to your business.

Alternatively, our **Elements** range offers the extreme **flexibility** that enables you to choose the combination of Planned Maintenance and Extended Warranty services for your business, and further enrich your package with the Additional Coverage elements.



<p>MAINTENANCE</p> <ul style="list-style-type: none"> - Maintenance - Lubrication - Oil and fluid changes according to the maintenance and repair handbook 	<p>DRIVE LINE</p> <ul style="list-style-type: none"> - Engine - Fuel injection - Gearbox - Propeller shaft and axle repairs 	<p>EXTRA DRIVE LINE</p> <ul style="list-style-type: none"> - Components not already covered by the drive line element e.g. Electrical System 	<p>WEAR</p> <ul style="list-style-type: none"> - Clutch - Brake pads - Brake discs - Brake drums - Brake linings for drum brakes
----------------------------------------------------------------------------------------------------------------------------------------------------------------------------------------------------	------------------------------------------------------------------------------------------------------------------------------------------------------------------------------	--------------------------------------------------------------------------------------------------------------------------------------------------------------------	--------------------------------------------------------------------------------------------------------------------------------------------------------------------------------------------

The major "elements" making up the offer (Maintenance, Drive Line, Extra Drive Line, Wear) can be combined in order to create the contract that perfectly suits your business. The table below summarises all the possible combinations:

PLANNED MAINTENANCE CONTRACTS

	MAINTENANCE	DRIVE LINE	EXTRA DRIVE LINE	WEAR
3XL-LIFE	•	•	•	•
2XL-LIFE	•	•	•	
XL-LIFE	•	•		•
L-LIFE	•	•		
M-LIFE	•			•
S-LIFE	•			

EXTENDED WARRANTY

	DRIVE LINE	EXTRA DRIVE LINE
XTRA XTENDED LIFE	•	•
XTENDED LIFE	•	

For inclusions/exclusions please refer to contractual documents relevant to your Market.

IVECO ACCESSORIES

IVECO | Accessories

The truck is much more than a vehicle: it is where thousands of people live and work every day. That's why IVECO Accessories created a range of tailor-made products to meet the driver's needs, improve their performance, enhance the vehicle's style and comfort, and introduce new technologies on board.

CUSTOMIZE YOUR IVECO T-WAY TO THE NEEDS OF YOUR BUSINESS

Customize your IVECO T-WAY to match your missions choosing from a wide range of high quality accessories developed to enhance the visibility, comfort, safety and profitability of your vehicle. Details that make the difference.



SAFETY&VISIBILITY

Choose from a range of accessories to increase your safety while driving; as the reversing safety systems proving a greater range of vision during manoeuvres and beacon which gives high visibility in all directions, recommended for emergency situations or special manoeuvres.



PROFITABILITY

To reduce overall TCO IVECO Accessories offer you a wide range of anti-siphon systems. The aluminium devices prevent diesel fuel theft, are indestructible, allow a quick refueling and are easy to install.



COMFORT

The IVECO Accessories seat covers and mats lines are perfectly integrated with the internal style of the cab. The choice of materials matches all mission requirements.



HI-TECH ON BOARD

Our accessories aim to make the drivers life on board as productive and comfortable as possible. The coffee machine will help them through long working days. The custom-made dashboard bracket with USB socket will safely hold their mobile device while it is charging.

The IVECO Accessories range is displayed in full in the accessories catalogue – and online at <http://application.cnh-parts-service.eu/iveco.php>



All customisation opportunities at hand with the "IVECO Accessories" free app.

The free app can be downloaded from App Store to get exclusive access to extra images and information.



IVECO SERVICES

IVECO CAPITAL

IVECO CAPITAL is the captive financial services Brand of IVECO, and offers a full range of financing, leasing, rental and ancillary services for commercial vehicles. Extended warranty, maintenance and repair services, and various types of insurance, can be included in the pack*.

All financial packs can be tailored to the Customer's needs, and apply to new, used vehicles and conversions.

For more information, please contact your IVECO Dealer.

*Subject to credit approval. Offerings and products may vary by country depending on the local fiscal and accounting regulations.



IVECO
0080048326000
Assistance Non-Stop



IVECO Assistance Non-Stop is just a phone call away 24 hours a day, 7 days a week to keep your IVECO T-WAY and your business running.

IVECO Non-Stop is the original IVECO smartphone application that you can use to communicate with IVECO if your vehicle breaks down. Just insert your vehicle information (VIN and registration plate) and with a simple push of a button you can send a request for assistance to the IVECO Customer Center. We will take care of your request immediately, activate the nearest workshop and follow up on the vehicle's repair. Through the app you can receive updates on the progress of your vehicle's assistance.









IVECO | **Genuine Parts**
HIGH PERFORMANCE

IVECO Genuine Parts represent the best guarantee of **safeguarding the value of IVECO T-WAY** over time, **protecting from unplanned downtime**, ensuring safety for people and goods. IVECO also offers the widest range of new and remanufactured components, servicing kits and telematics solutions, suitable for every stage of the IVECO T-WAY's lifecycle. IVECO operates a network of 7 parts depots across AMEA Region, covering over 40,000 sqm, managing 105,000 part numbers and guaranteeing 24/7 parts delivery.









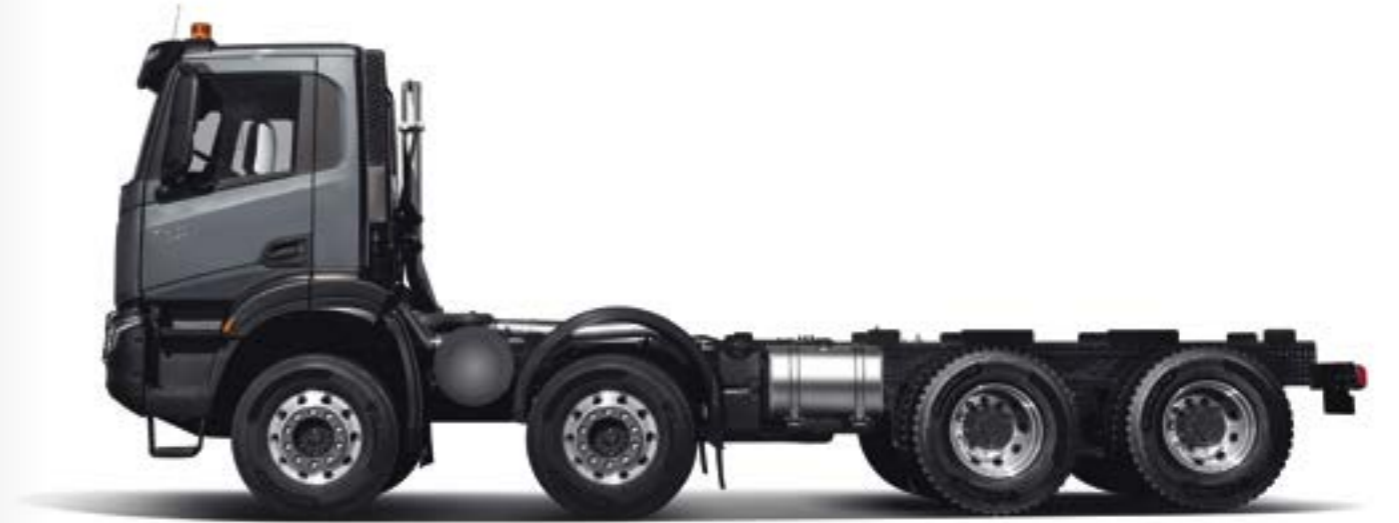



IVECO is a brand of CNH Industrial N.V., a global leader in the capital goods sector that, through its various businesses, designs, produces and sells agricultural and construction equipment, trucks, commercial vehicles, buses and specialty vehicles, in addition to a broad portfolio of powertrain applications. It also distributes high performance genuine parts for all CNH Industrial Commercial Brands.

CHOOSE YOUR IVECO T-WAY MODEL

IVECO T-WAY		ARTIC		
		6x4 (PWD)	4x4 (AWD) - Only LHD	6x6 (AWD) - Only LHD
CAB ROOF	AT			
	AD			
ENGINE / GEARBOX	Cursor 13	Automated / Manual	Automated / Manual	Automated / Manual
REAR AXLE / SUSPENSION (BRAKES)	HR	Steel susp. (DRUM & DISC) Air susp. (DISC)	Steel susp. (DRUM)	Steel susp. (DRUM)
VEHICLE SETUP		OFF	OFF	OFF
CHASSIS		10 mm	7.7 mm	10 mm
WHEELBASES (mm)		3300 - 3500	3800	3500 - 3800



IVECO T-WAY		RIGID				
		6x4 (PWD)	8x4 (PWD)	4x4 (AWD)	6x6 (AWD)	8X8 (AWD) - Only LHD
CAB ROOF	AT					
	AD					
ENGINE / GEARBOX	Cursor 13	Automated / Manual	Automated / Manual	Automated / Manual	Automated / Manual	Automated / Manual
REAR AXLE / SUSPENSION (BRAKES)	HR	Steel susp. (DRUM & DISC)	Steel susp. (DRUM & DISC)	Steel susp. (DRUM)	Steel susp. (DRUM)	Steel susp. (DRUM)
VEHICLE SETUP		OFF	OFF	OFF	OFF	OFF
CHASSIS		10 mm	10 mm	10 mm	10 mm	10 mm
WHEELBASES (mm)		3300 - 3500 - 3800 - 4200 - 4500	4.500 - 4750 - 5020 - 5820 *LHD: 4500 - 4750 - 5020 - 5820 *RH-D: 4750 - 5020 - 5820	3800 - 4200 - 4500	3.500 - 3800 - 4200 - 4500	4750 - 5020

*Only T-WAY EuroV



IVECO
Your partner for sustainable transport